

TRAINER

PALESTRA ALL' APERTO

OUTDOORSTART

OUTDOORFIT

OUTDOORDISABILE

STREET WORKOUT

STREET NINJA









OUTDOORSTEEL4FIT



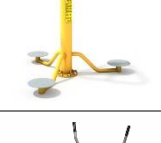





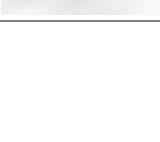

OUTDOORSETS











LISTINO PREZZI 2025

www.outdoor-gym.com/it/



VISUALIZZAZIONE	ATTREZZATURE NOME	* PREZZO
	DISTENSIONE PUSH DA SEDUTO - SINGOLO	R01A 1 320 €
	DISTENSIONE PUSH DA SEDUTO INTEGRATIVO DISABILI+ PALO	D01R+SI+SLW2 1 860 €
	DISTENSIONE PUSH DA SEDUTO - DOPPIO	R01B 2 150 €
	TRAZIONE PULL VERTICALE - SINGOLO	R02A 1 320 €
	TRAZIONE PULL VERTICALE INTEGRATIVO DISABILI + PALO	D02R+SI+SLW2 1 850 €
	TRAZIONE PULL VERTICALE - DOPPIO	R02B 2 150 €
	PENDOLO FITNESS- SINGOLO	R03A 1 020 €
	PENDOLO FITNESS- DOPPIO	R03B 1 280 €
	RUNNER	R04 1 170 €
	LEG PRESS - SINGOLO	R05A 1 270 €

VISUALIZZAZIONE	ATTREZZATURE NOME		* PREZZO
	LEG PRESS - DOPPIO	R05B	1 795 €
	TWISTER - SINGOLO	R08A	970 €
	TWISTER - DOPPIO	R08B	1170 €
	TWISTER - TRIPLO	R08C	1 360 €
	ELLITTICA	R11	1 280 €
	CRUNCH	R15	1 120 €
	ROUTE TAI CHI - SINGOLO	R18A	995 €
	ROUTE TAI CHI - DOPPIO	R18B	1 245 €
	TIMONE - SINGOLO	R19A	1 025 €
	TIMONE - DOPPIO	R19B	1 275 €

VISUALIZZAZIONE	ATTREZZATURE NOME		* PREZZO
	STEPPER - SINGOLO	R21A	1 300 €
	STEPPER - DOPPIO	R21B	1 550 €
	PATTINATORE - SINGOLO	R22A	1 175 €
	PATTINATORE - DOPPIO	R22B	1 375 €
	ADDUTTORE - SINGOLO	R24A	1 130 €
	CYCLETTE	R25	930 €
	CYCLETTE	R25S	1 040 €
	BARRE FITNESS	R30	880 €
	VOGATORE	R31	1 120 €
	SOLLEVATORE BRACCIA	R50	1 260 €

VISUALIZZAZIONE	ATTREZZATURE NOME		* PREZZO
	SOLLEVATORE GAMBE	R51	1 150 €
	COORDINATORE DISABILE	R52	850 €
	TAPIS ROULANT	R54	2 650 €
	DISTENSIONE PUSH DA SEDUTO & TRAZIONE PULL VERTICALE	M01	2 150 €
	MASSAGGIATORE VERTICALE & ORIZZONTALE	M02	1 485 €
	ROUTE TAI CHI & TIMONE	M03	1 300 €
	TWISTER & PENDOLO FITNESS	M04	1 200 €
	ADDUTTORE & STEPPER	M07	1 480 €
	PENDOLO FITNESS + RUNNER + TWISTER	M15	2 150 €
	STEPPER + RUNNER + ADDUTTORE	M16	2 390 €

VISUALIZZAZIONE	ATTREZZATURE NOME		* PREZZO
	RUNNER - DOPPIO	M20	2 050 €
	PANCHINA CON PEDALI	M21	1 295 €
	PEDALI DA PANCHINA	M21PED	920 €
	FARFALLA FITNESS	D06R+SZ+SLW2	1 800 €
	FARFALLA FITNESS INTEGRATIVO DISABILI + PALO	D06R+SI+SLW2	2 180 €
	FARFALLA FITNESS INVERSA	D07R+SZ+SLW2	1 800 €
	FARFALLA FITNESS INVERSA INTEGRATIVO DISABILI + PALO	D07R+SI+SLW2	2 180 €
	PANCA	D10+SLN1	835 €
	PANCA & RADDRIZZATORE SCHIENA	D10+SLN2+D14	1 295 €
	DISTENSIONE DA SDRAIATI	R20	1 850 €

VISUALIZZAZIONE	ATTREZZATURE NOME		* PREZZO
	SCALETTA	D29+SLW2	865 €
	SCHEDA INFORMATIVA CON REGOLAMENTO	TAB1	280 €

*** PREZZO NETTO**

I prezzi dei dispositivi non includono il trasporto e il montaggio.

Le attrezzature per gli esercizi all'aperto sono conformi alle disposizioni della norma EN 16630:2015.

**** MATERIALI E PRODUZIONE**

Le palestre all'aperto sono realizzate in acciaio di alta qualità. I sedili sono realizzati con pannelli in HDPE ed i gradini in alluminio. Per garantire un'alta protezione dalla corrosione le attrezzature vengono sottoposte a sabbiatura ad alta pressione, alla zincatura ed a doppia verniciatura a polvere. Il primo strato è un rivestimento in zinco di alta qualità, mentre il secondo strato è una vernice in poliestere resistente alle variabili condizioni atmosferiche.

***** INTEGRATIVO**

Grazie al meccanismo del sedile sollevabile, l'attrezzo è adatto anche a persone in sedia a rotelle.

**** COLORI

I nostri colori standard sono:

Gallo

RAL 1018 and 7004



Grafite

RAL 7016 and 9006



Arancio

RAL 2000 and 9006

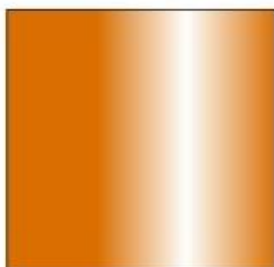





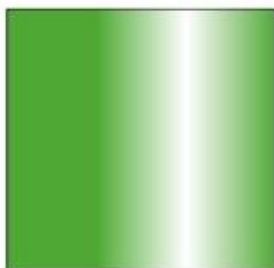















Lime











RAL 6018 and 9006











* È possibile cambiare il colore per qualsiasi tavolozza RAL a un costo aggiuntivo.

VISUALIZZAZIONE	ATTREZZATURE NOME		* PREZZO (SENZA PILONE/PALO)
	DISTENSIONE PUSH DA SEDUTO	D01	1 050 €
	TRAZIONE PULL VERTICALE	D02	1 050 €
	PENDOLO FITNESS	D03	840 €
	RUNNER	D04	1 170 €
	LEG PRESS	D05	1 160 €
	FARFALLA FITNESS	D06R+SZ	1 410 €
	FARFALLA FITNESS INVERSA	D07R+SZ	1 410 €
	TWISTER	D08	550 €
	PANCA	D10	520 €
	ELLITTICA	D11	1 230 €

VISUALIZZAZIONE	ATTREZZATURE NOME		* PREZZO (SENZA PILONE/PALO)
	MASSAGGIATORE VERTICALE	D12	840 €
	MASSAGGIATORE ORIZZONTALE	D13	1 060 €
	RADDRIZZATORE SCHIENA	D14	460 €
	CRUNCH	D15	1 060 €
	BARRE DI TRAZIONE	D16	430 €
	RUOTE TAI CHI	D18	899 €
	TIMONE	D19	925 €
	DISTENSIONE DA SDRAIATI	D20	1 350 €
	STEPPER	D21	1 230 €
	PATTINATORE	D22	1 195 €

VISUALIZZAZIONE	ATTREZZATURE NOME		* PREZZO (SENZA PILONE/PALO)
	ADDUTTORE	D24	990 €
	CYCLETTE	D25	930 €
	CYCLETTE	D25S	1 070 €
	RAISING LEG	D28	510 €
	SCALETTA	D29	425 €
	BARRE FITNESS	D30	460 €
	VOGATORE	D31	1 070 €
	SOLLEVATORE BRACCIA	D50	1 190 €
	SOLLEVATORE GAMBE	D51	1 150 €
	DISTENSIONE PUSH DA SEDUTO INTEGRATIVO DISABILI	D01R+SI	1 465 €

VISUALIZZAZIONE	ATTREZZATURE NOME		* PREZZO (SENZA PILONE/PALO)
	TRAZIONE PULL VERTICALE INTEGRATIVO DISABILI	D02R+SI	1 465 €
	FARFALLA FITNESS INTEGRATIVO DISABILI	D06R+SI	1 785 €
	FARFALLA FITNESS INVERSA DISABILE	D07R+SI	1 785 €
	PILONE	P01	499 €
	TRIPLO PILONE	P03	1 015 €
	QUADRUPLO PILONE	P04	1 295 €
	ALTO PALO	SLW	440 €
	BREVE PALO	SLN	315 €
	SCHEDA INFORMATIVA CON REGOLAMENTO	TAB1	280 €

*** PREZZO NETTO**

I prezzi dei dispositivi non includono il trasporto e il montaggio.

Al prezzo deve essere aggiunto un pilone o un palo (un supporto per dispositivi).











Le attrezzature per gli esercizi all'aperto sono conformi alle disposizioni della norma EN 16630:2015.

**** MATERIALI E PRODUZIONE**

Le palestre all'aperto sono realizzate in acciaio di alta qualità. I sedili sono realizzati con pannelli in HDPE ed i gradini in alluminio. Per garantire un'alta protezione dalla corrosione le attrezzature vengono sottoposte a sabbiatura ad alta pressione, alla zincatura ed a doppia verniciatura a polvere. Il primo strato è un rivestimento in zinco di alta qualità, mentre il secondo strato è una vernice in poliestere resistente alle variabili condizioni atmosferiche. I colori di serie dei macchinari sono giallo e grigio -RAL 1018 e RAL 7004, grafite e argento – RAL 7016 e 9006, arancio e argento – RAL 2000 e 9006, lime e argento – RAL 6018 e 9006.

***** INTEGRATIVO**

Grazie al meccanismo del sedile sollevabile, l'attrezzo è adatto anche a persone in sedia a rotelle.

VISUALIZZAZIONE	ATTREZZATURE NOME		* PREZZO (SENZA PILONE/PALO)
	DISTENSIONE DA SEDUTO DISABILE	D01R+WS	955 €
	DISTENSIONE PUSH DA SEDUTO INTEGRATIVO DISABILI	D01R+SI	1 465 €
	TRAZIONE PULL VERTICALE DISABILE	D02R+ WS	955 €
	TRAZIONE PULL VERTICALE INTEGRATIVO DISABILI	D02R+SI	1 465 €
	FARFALLA FITNESS DISABILE	D06R+ WS	1 250 €
	FARFALLA FITNESS INTEGRATIVO DISABILI	D06R+SI	1 785 €
	FARFALLA FITNESS INVERSA DISABILE	D07R+ WS	1 250 €
	FARFALLA FITNESS INVERSA INTEGRATIVO DISABILI	D07R+SI	1 785 €
	ROUTE TAI CHI DISABILE	E18	950 €
	TIMONE DISABILE	E19	940 €

VISUALIZZAZIONE	ATTREZZATURE NOME		* PREZZO (SENZA PILONE/PALO)
	STEPPER DISABILE	E21	1 600 €
	CYCLETTE DISABILE	E25	999 €
	CYCLETTE MANUALE	E32	950 €
	STAFFA PULL-UP DISABILE	E33	760 €
	TWISTER SUPERIORE DISABILE	E34	780 €
	MACCHINARIO PER L'ALLENAMENTO DELLE BRACCIA DISABILE	E35	805 €
	MACCHINARIO PER L'ALLENAMENTO PARTE BASSA DELLE BRACCIA DISABILE	E36	1 015 €
	MACCHINARIO PER L'ALLENAMENTO ALTO DISABILE	E37	1 015 €

VISUALIZZAZIONE	ATTREZZATURE NOME		* PREZZO (SENZA PILONE/PALO)
	PILONE	P01	499 €
	PILONE TRIPLO	P03	1 015 €
	PILONE QUADRUPLO	P04	1 295 €
	ALTO PALO	SLW	440 €
	BREVE PALO	SLN	315 €

*** PREZZO NETTO**

I prezzi dei dispositivi non includono il trasporto e il montaggio.

Al prezzo deve essere aggiunto un pilone o un palo (un supporto per dispositivi).









Le attrezzature per gli esercizi all'aperto sono conformi alle disposizioni della norma EN 16630:2015.



**** MATERIALI E PRODUZIONE**

Le palestre all'aperto sono realizzate in acciaio di alta qualità. I sedili sono realizzati con pannelli in HDPE ed i gradini in alluminio. Per garantire un'alta protezione dalla corrosione le attrezzature vengono sottoposte a sabbiatura ad alta pressione, alla zincatura ed a doppia verniciatura a polvere. Il primo strato è un rivestimento in zinco di alta qualità, mentre il secondo strato è una vernice in poliesteri resistente alle variabili condizioni atmosferiche. I colori di serie dei macchinari sono giallo e grigio -RAL 1018 e RAL 7004, grafite e argento – RAL 7016 e 9006, arancio e argento – RAL 2000 e 9006, lime e argento – RAL 6018 e 9006.

***** INTEGRATIVO**

Grazie al meccanismo del sedile sollevabile, l'attrezzo è adatto anche a persone in sedia a rotelle.

VISUALIZZAZIONE	ATTREZZATURE NOME		* PREZZO (SENZA PILONE/PALO)
	DISTENSIONE DA SEDUTO & TRAZIONE PULL VERTICALE - DISABILE	E38	2 170 €
	STEPPER DISABILE & CYCLETTE DISABILE	E39	2 240 €
	ROUTE TAI CHI & TIMONE DISABILE	E40	1 335 €
	CYCLETTE MANUALE & STAFFA PULL-UP DISABILE	E41	1 690 €
	MACCHINARIO PER L'ALLENAMENTO DELLE BRACCIA & TWISTER SUPERIORE DISABILE	E42	1 750 €
	MACCHINARIO PER L'ALLENAMENTO ALTO & PARTE BASSA DELLE BRACCIA DISABILE	E43	1 869 €
	MULINELLO DISABILE	E44	1 489 €
	BICI INCLINATA DISABILE	E45	1 650 €
	MACCHINARIO MULTIFUNZIONE A TRE POSTAZIONI DISABILE	E46	2 700 €
	MACCHINARIO MULTIFUNZIONE A DUE POSTAZIONI DISABILE	E47	2 139 €

VISUALIZZAZIONE	ATTREZZATURE NOME		* PREZZO (SENZA PILONE/PALO)
	CANESTRO DISABILE	E49	2 559 €
	COORDINATORE	R52	850 €
	SCHEDA INFORMATIVA CON REGOLAMENTO	TAB1	280 €

*** PREZZO NETTO**

I prezzi dei dispositivi non includono il trasporto e il montaggio.

Al prezzo deve essere aggiunto un pilone o un palo (un supporto per dispositivi).

Le attrezzature per gli esercizi all'aperto sono conformi alle disposizioni della norma EN 16630:2015.

**** MATERIALI E PRODUZIONE**



Le palestre all'aperto sono realizzate in acciaio di alta qualità. I sedili sono realizzati con pannelli in HDPE ed i gradini in alluminio. Per garantire un'alta protezione dalla corrosione le attrezzature vengono sottoposte a sabbiatura ad alta pressione, alla zincatura ed a doppia verniciatura a polvere. Il primo strato è un rivestimento in zinco di alta qualità, mentre il secondo strato è una vernice in poliestere resistente alle variabili condizioni atmosferiche. I colori di serie dei macchinari sono giallo e grigio -RAL 1018 e RAL 7004, grafite e argento – RAL 7016 e 9006, arancio e argento – RAL 2000 e 9006, lime e argento – RAL 6018 e 9006.









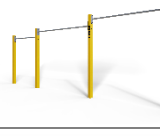

***** INTEGRATIVO**

Grazie al meccanismo del sedile sollevabile, l'attrezzo è adatto anche a persone in sedia a rotelle.

VISUALIZZAZIONE	ATTREZZATURE NOME		* PREZZO
	SCALETTA	SW01A	995 €
	SCALETTA	SW01B	970 €
	SCALA CON BRACCIO	SW01C	1 250 €
	BARRA	SW02A	795 €
	BARRA 2000	SW02B	820 €
	BARRE PARALLELE PER PALO	SW03A	875 €
	DOPPI BARRE PARALLELE PER PALO	SW03B	1 280 €
	BARRE PARALLELE	SW04A	520 €
	BARRES PARALLÈLES BASSES	SW04B	390 €
	SCALETTA ORIZZONTALE	SW05A	1 470 €

VISUALIZZAZIONE	ATTREZZATURE NOME	* PREZZO
	SCALETTA ORIZZONTALE CON MANIGLIE	SW05B 1 635 €
	SCALETTA ORIZZONTALE LUNGA	SW05C 1 540 €
	BARRA ORIZZONTALE CON MANIGLIE	SW09A 1 320 €
	BASTONE ORIZZONTALE CON SERPENTE	SW09B 1 315 €
	PONTICELLO	SW10 1 840 €
	SLALOM	SW11 1 990 €
	TUBO VERTICALE	SW12 650 €
	CORDA	SW14 900 €
	CORDA SOSPESA	SW14A 690 €
	ANELLI	SW15 1 125 €

VISUALIZZAZIONE	ATTREZZATURE NOME		* PREZZO
	ANELLI SOSPESI	SW15A	1 440 €
	SACCA DA BOXE	SW16	1 090 €
	ABDO INCLINATO	SW17	1 220 €

VISUALIZZAZIONE	ATTREZZATURE NOME		*PREZZO
	STREET WORKOUT PARK 01	SWN01	2 450 €
	STREET WORKOUT PARK 02	SWN02	3 500 €
	STREET WORKOUT PARK 03	SWN03	1 650 €
	STREET WORKOUT PARK 04	SWN04	2 200 €
	STREET WORKOUT PARK 05	SWN05	2 270 €
	STREET WORKOUT PARK 06	SWN06	4 620 €
	STREET WORKOUT PARK 07	SWN07	5 040 €
	STREET WORKOUT PARK 08	SWN08	5 260 €
	STREET WORKOUT PARK 09	SWN09	7 320 €
	STREET WORKOUT PARK 10	SWN10	7 950 €

VISUALIZZAZIONE	ATTREZZATURE NOME		*PREZZO
	STREET WORKOUT PARK 11	SWN11	21 990 €
	STREET WORKOUT PARK 12	SWN12	4 350 €

*** PREZZO NETTO**







I prezzi dei dispositivi non includono il trasporto e il montaggio.

Le attrezzature per gli esercizi all'aperto sono conformi alle disposizioni della norma EN 16630:2015.

**** MATERIALI E PRODUZIONE**

Le palestre all'aperto sono realizzate in acciaio di alta qualità. I sedili sono realizzati con pannelli in HDPE ed i gradini in alluminio. Per garantire un'alta protezione dalla corrosione le attrezzature vengono sottoposte a sabbiatura ad alta pressione, alla zincatura ed a doppia verniciatura a polvere. Il primo strato è un rivestimento in zinco di alta qualità, mentre il secondo strato è una vernice in poliestere resistente alle variabili condizioni atmosferiche. I colori di serie dei macchinari sono giallo e grigio -RAL 1018 e RAL 7004, grafite e argento – RAL 7016 e 9006, arancio e argento – RAL 2000 e 9006, lime e argento – RAL 6018 e 9006.

Su richiesta del cliente è possibile scegliere un colore diverso, con supplemento.

VISUALIZZAZIONE	ATTREZZATURE NOME		*PREZZO
	HOT WHEELS	TN-HW	2 300 €
	LIANE DI TARZAN	TN-LT	1 995 €
	MULTIRING	TN-M	2 445 €
	MAZZE NINJA	TN-MN	2 099 €
	LEVE NINJA	TN-ND	2 139 €
	MANIGILIE MOBILI	TN-RU	1 949 €

*** PREZZO NETTO**



I prezzi dei dispositivi non includono il trasporto e il montaggio.

Le attrezzature per gli esercizi all'aperto sono conformi alle disposizioni della norma EN 16630:2015.

**** MATERIALI E PRODUZIONE**







Le palestre all'aperto sono realizzate in acciaio di alta qualità. I sedili sono realizzati con pannelli in HDPE ed i gradini in alluminio. Per garantire un'alta protezione dalla corrosione le attrezzature vengono sottoposte a sabbiatura ad alta pressione, alla zincatura ed a doppia verniciatura a polvere. Il primo strato è un rivestimento in zinco di alta qualità, mentre il secondo strato è una vernice in poliestere resistente alle variabili condizioni atmosferiche. I colori di serie dei macchinari sono giallo e grigio -RAL 1018 e RAL 7004, grafite e argento - RAL 7016 e 9006, arancio e argento - RAL 2000 e 9006, lime e argento - RAL 6018 e 9006.

Su richiesta del cliente è possibile scegliere un colore diverso, con supplemento.

VISUALIZZAZIONE	ATTREZZATURE NOME	* PREZZO
	DISTENSIONE PUSH DA SEDUTO - SINGOLO	R01A STEEL4FIT 1 590 €
	DISTENSIONE PUSH DA SEDUTO INTEGRATIVO DISABILI + PALO STEEL4FIT	D01R+SI+SLW2 STEEL4FIT 2 380 €
	TRAZIONE PULL VERTICALE – SINGOLO STEEL4FIT	R02A STEEL4FIT 1 590 €
	TRAZIONE PULL VERTICALE INTEGRATIVO DISABILI+ PALO STEEL4FIT	D02R+SI+SLW2 STEEL4FIT 2 380 €
	PENDOLO FITNESS- SINGOLO STEEL4FIT	R03A STEEL4FIT 1 215 €
	LEG PRESS- SINGOLO STEEL4FIT	R04 STEEL4FIT 1 390 €
	LEG PRESS- SINGOLO STEEL4FIT	R05A STEEL4FIT 1 540 €
	LEG PRESS - DOPPIO STEEL4FIT	R05B STEEL4FIT 2 075 €
	TWISTER- SINGOLO STEEL4FIT	R08A STEEL4FIT 1 190 €
	ELLITTICA STEEL4FIT	R11 STEEL4FIT 1 470 €



VISUALIZZAZIONE	ATTREZZATURE NOME		* PREZZO
	CRUNCH STEEL4FIT	R15 STEEL4FIT	1 295 €
	ROUTE TAI CHI- SINGOLO STEEL4FIT	R18A STEEL4FIT	1 290 €
	TIMONE STEEL4FIT	R19A STEEL4FIT	1 290 €
	STEPPER - SINGOLO STEEL4FIT	R21A STEEL4FIT	1 590 €
	PATTINATORE - SINGOLO STEEL4FIT	R22A STEEL4FIT	1 495 €
	ADDUTTORE SINGOLO STEEL4FIT	R24A STEEL4FIT	1 375 €
	BARRE FITNESS STEEL4FIT	R30 STEEL4FIT	1 035 €
	VOGATORE STEEL4FIT	R31 STEEL4FIT	1 295 €
	DISTENSIONE PUSH DA SEDUTO + TRAZIONE PULL VERTICALE STEEL4FIT	M01 STEEL4FIT	2 450 €
	MASSAGGIATORE VERTICALE & ORIZZONTALE STEEL4FIT	M02 STEEL4FIT	1 550 €

VISUALIZZAZIONE	ATTREZZATURE NOME		* PREZZO
	RUOTE TAI CHI & TIMONE STEEL4FIT	M03 STEEL4FIT	1 550 €
	TWISTER&PENDOLO FITNESS STEEL4FIT	M04 STEEL4FIT	1 370 €
	TWISTER & STEPPER	M05 STEEL4FIT	1 400 €
	ABDUCTOR & STEPPER	M07 STEEL4FIT	1 590 €
	PANCA + RUNNER + ADDUTTORE STEEL4FIT	M14 STEEL4FIT	2 550 €
	PENDOLO FITNESS+ RUNNER+ TWISTER STEEL4FIT	M15 STEEL4FIT	2 490 €
	STEPPER + RUNNER + ADDUTTORE STEEL4FIT	M16 STEEL4FIT	2 650 €
	FARFALLA FITNESS STEEL4FIT	D06R+SZ+SLW2 STEEL4FIT	2 380 €
	FARFALLA FITNESS INTEGRATIVO DISABILI + PALO STEEL4FIT	D06R+SI+SLW2 STEEL4FIT	2 580 €
	FARFALLA FITNESS INVERSA + PALO STEEL4FIT	D07R+SZ+SLW2 STEEL4FIT	2 380 €







VISUALIZZAZIONE	ATTREZZATURE NOME		* PREZZO
	FARFALLA FITNESS INVERSA INTEGRATIVO DISABILI + PALO STEEL4FIT	D07R+SI+SLW2 STEEL4FIT	2 580 €
	PANCA STEEL4FIT	D10+SLN1 STEEL4FIT	1 180 €
	PANCA+ RADDRIZZATORE SCHIENA STEEL4FIT	D10+SLN2+D14 STEEL4FIT	1 870 €
	DISTENSIONE DA SDRAIATI STEEL4FIT	D20+SLN1 STEEL4FIT	2 050 €
	SCALETTA STEEL4FIT	D29+SLW2 STEEL4FIT	1 180 €
	SCHEDA INFORMATIVA CON REGOLAMENTO STEEL4FIT	TAB1 STEEL4FIT	490 €



VISUALIZZAZIONE	ATTREZZATURE NOME		* PREZZO (SENZA PILONE/PALO)
	DISTENSIONE PUSH DA SEDUTO STEEL4FIT	D01 STEEL4FIT	1 290 €
	TRAZIONE PULL VERTICALE STEEL4FIT	D02 STEEL4FIT	1 290 €
	PENDOLO FITNESS STEEL4FIT	D03 STEEL4FIT	890 €
	RUNNER STEEL4FIT	D04 STEEL4FIT	1 390 €
	LEG PRESS STEEL4FIT	D05 STEEL4FIT	1 150 €
	FARFALLA FITNESS STEEL4FIT	D06R+SZ STEEL4FIT	1 790 €
	FARFALLA FITNESS INVERSA STEEL4FIT	D07R+SZ STEEL4FIT	1 790 €
	TWISTER	D08 STEEL4FIT	690 €
	PANCA STEEL4FIT	D10 STEEL4FIT	690 €
	ELLITTICA STEEL4FIT	D11 STEEL4FIT	1 470 €

VISUALIZZAZIONE	ATTREZZATURE NOME		* PREZZO (SENZA PILONE/PALO)
	MASSAGGIATORE VERTICALE STEEL4FIT	D12 STEEL4FIT	920 €
	MASSAGGIATORE ORIZZONTALE STEEL4FIT	D13 STEEL4FIT	960 €
	RADDRIZZATORE SCHIENA STEEL4FIT	D14 STEEL4FIT	690 €
	CRUNCH STEEL4FIT	D15 STEEL4FIT	1 295 €
	BARRE DI TRAZIONE STEEL4FIT	D16 STEEL4FIT	570 €
	RUOTE TAI CHI STEEL4FIT	D18 STEEL4FIT	1 130 €
	TIMONE STEEL4FIT	D19 STEEL4FIT	1 130 €
	DISTENSIONE DA SDRAIATI STEEL4FIT	D20 STEEL4FIT	1 550 €
	STEPPER	D21 STEEL4FIT	1 150 €
	PATTINATORE STEEL4FIT	D22 STEEL4FIT	1 450 €

VISUALIZZAZIONE	ATTREZZATURE NOME		* PREZZO (SENZA PILONE/PALO)
	ADDUTTORE STEEL4FIT	D24 STEEL4FIT	1 250 €
	RAISING LEG	D28 STEEL4FIT	590 €
	SCALETTA STEEL4FIT	D29 STEEL4FIT	590 €
	BARRE FITNESS STEEL4FIT	D30 STEEL4FIT	590 €
	VOGATORE STEEL4FIT	D31 STEEL4FIT	1 320 €
	ARM LIFT TRAINER	D50 STEEL4FIT	1 290 €
	LEG LIFTER	D51 STEEL4FIT	1 290 €
	DISTENSIONE PUSH DA SEDUTO INTEGRATIVO DISABILI STEEL4FIT	D01R+SI STEEL4FIT	1 790 €
	TRAZIONE PULL VERTICALE INTEGRATIVO DISABILI STEEL4FIT	D02R+SI STEEL4FIT	1 790 €
	FARFALLA FITNESS INTEGRATIVO DISABILI STEEL4FIT	D06R+SI STEEL4FIT	1 990 €

VISUALIZZAZIONE	ATTREZZATURE NOME		* PREZZO (SENZA PILONE/PALO)
	FARFALLA FITNESS INVERSA INTEGRATIVO DISABILI STEEL4FIT	D07R+SI STEEL4FIT	1 990 €
	PILONE STEEL4FIT	P01 STEEL4FIT	690 €
	PILONE TRIPLO STEEL4FIT	P03 STEEL4FIT	1 390 €
	QUADRUPLE PYLON STEEL4FIT	P04 STEEL4FIT	1 690 €
	HIGH POLE	SLW STEEL4FIT	590 €
	LOW POLE	SLN STEEL4FIT	490 €

*** PREZZO NETTO**

I prezzi dei dispositivi non includono il trasporto e il montaggio.

Al prezzo deve essere aggiunto un pilone (un supporto per dispositivi).

Le attrezzature per gli esercizi all'aperto sono conformi alle disposizioni della norma EN 16630:2015.

**** MATERIALI E PRODUZIONE**

L'attrezzatura era realizzata in acciaio per saldatura di alta qualità. I componenti piegati erano realizzati in acciaio senza saldatura S355,

e componenti rettilinei - in acciaio S235.

Per garantire un'elevata protezione dalla corrosione, i dispositivi sono zincati a caldo e verniciati a polvere due volte. Sedili in pannello HDPE e gradini in alluminio.

Colori dell'attrezzatura in rosso e grafite (RAL: 3000 e 7016).

***** INTEGRATIVO**

Grazie al meccanismo del sedile sollevabile, l'attrezzo è adatto anche a persone in sedia a rotelle.

Set 1



Set numero 1 per giovani e adulti. Un set universale contenente attrezzature per l'esercizio di varie parti del corpo.

Il kit è composto da:

- 1** Ellittica
- 2** Runner
- 3** Vogatore

Prezzo scontato: **3.391,50 € IVA esclusa**

Prezzo attrezzatura a parte: 3.570,00 € IVA esclusa

Set 2



Set numero 2 per giovani e adulti. Un set universale contenente attrezzature per l'esercizio di varie parti del corpo.

Il kit è composto da:

- 1** Vogatore
- 2** Ellittica
- 3** Runner
- 4** Leg press
- 5** Twister& Pendolo
- 6** Distensione push da seduto

Prezzo scontato: **6.771,20 € IVA esclusa**

Prezzo attrezzatura a parte: 7.360,00 € IVA esclusa

Set 3



Set numero 3 per giovani e adulti. Un set universale contenente attrezzature per l'esercizio di varie parti del corpo.

Il kit è composto da:

- 1** Distensione push da seduto
- 2** Twister&pendolo fitness
- 3** Veslařský Trenažér
- 4** Ruote tai chi & timone
- 5** Runner
- 6** Leg Press

Prezzo scontato: **6.789,60 € IVA esclusa**

Prezzo attrezzatura a parte: 7.380,00 € IVA esclusa

Set 4



Set numero 4 per giovani e adulti. Un set universale contenente attrezzature per l'esercizio di varie parti del corpo.

Il kit è composto da:

- 1 Massaggiatore verticale&orizzontale
- 2 Panchina con pedali
- 3 Coordinatore disabile
- 4 Ruote tai chi & Timone
- 5 Twister&pendolo fitness
- 6 Runner

Prezzo scontato: **6.716,00 € IVA esclusa**

Prezzo attrezzatura a parte: 7.300,00 € IVA esclusa

Set 5



Set numero 5 per giovani e adulti. Un set universale contenente attrezzature per l'esercizio di varie parti del corpo.

Il kit è composto da:

- 1 Distensione push da seduto
- 2 Runner
- 3 Leg press
- 4 Ellittica
- 5 Vogatore
- 6 Ruote tai chi & timone
- 7 Twister & pendolo fitness
- 8 Scaletta
- 9 Panchina con pedali

Prezzo scontato: **9.738,00 € IVA esclusa**

Prezzo attrezzatura a parte: 10.820,00 € IVA esclusa

Set 6



Set numero 6 per giovani e adulti. Un set universale contenente attrezzature per l'esercizio di varie parti del corpo.

Il kit è composto da:

- 1** Distensione push da seduto
- 2** Ellittica
- 3** Runner
- 4** Leg Press
- 5** Vogatore
- 6** Scaletta
- 7** Farfalla fitness integrativo disabili
- 8** Ruote tai chi & timone
- 9** Panca+ raddrizzatore schiena

Prezzo scontato: **10.620,00 € IVA esclusa**

Prezzo attrezzatura a parte: 11.800,00 € IVA esclusa

Set 7

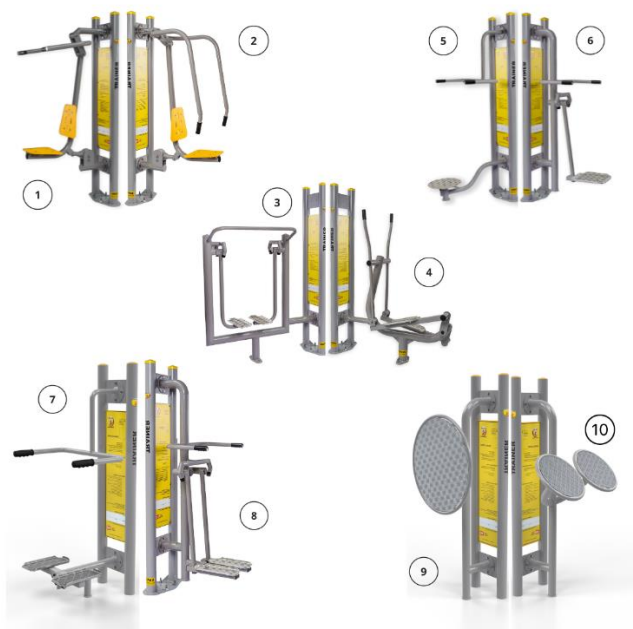

Set numero 7 per giovani e adulti. Un set universale contenente attrezzature per l'esercizio di varie parti del corpo.

Il kit è composto da:

- 1** Distensione push da seduto
- 2** Trazione pull verticale
- 3** Ellittica
- 4** Runner
- 5** Twister
- 6** Pendolo Fitness
- 7** Stepper
- 8** Adduttore
- 9** Timone
- 10** Ruote Tai Chi

Prezzo scontato: **11.186,10 € IVA esclusa**

Prezzo attrezzatura a parte: 12.429,00 € IVA esclusa

Set 8



Set numero 6 per giovani e adulti. Un set universale contenente attrezzature per l'esercizio di varie parti del corpo.

Il kit è composto da:

1. **Ellittica**
2. **Distensione push da seduto + trazione pull verticale**
3. **Pendolo fitness+ runner+ twister**

Prezzo scontato: **5.133,60 € IVA esclusa**

Prezzo attrezzatura a parte: 5.580,00 € IVA esclusa